

Satel®

XD-2

Multipurpose detector

CE

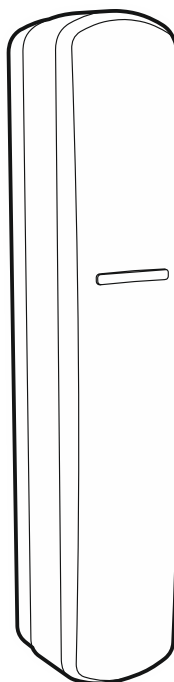

EN

Firmware version 1.00

xd-2_en 05/21

SATEL sp. z o.o. • ul. Budowlanych 66 • 80-298 Gdańsk • POLAND
tel. +48 58 320 94 00
www.satel.eu

IMPORTANT

The device should be installed by qualified personnel.

Prior to installation, please read carefully this manual.

Changes, modifications or repairs not authorized by the manufacturer shall void your rights under the warranty.

The rating plate of the device is located on the enclosure base.

SATEL aims to continually improve the quality of its products, which may result in changes in their technical specifications and software. Current information about the changes being introduced is available on our website.

Please visit us at:
<http://support.satel.eu>

The declaration of conformity may be consulted at www.satel.eu/ce

The following symbols may be used in this manual:



- note;



- caution.

CONTENTS

1.	Features	2
2.	Description.....	2
	Alarms	2
	Additional alarm output	3
	Supply voltage control	3
	LED indicator	3
3.	Electronics board	4
4.	Configuring the detector settings	5
	Selecting the detector type	5
	Two output mode enable / disable	5
	LED enable / disable.....	6
	Configuring the shock detector settings.....	6
5.	Installation	6
6.	Detector test	9
7.	Specifications	9

The XD-2 detector can work as:

- magnetic contact,
- shock detector,
- shock detector and magnetic contact,
- water flood detector.

This manual applies to the detector with firmware version 1.4.

1. Features

- Detector type selected with DIP switches.
- LED indicator.
- Remote LED enable / disable.
- Supply voltage control.
- Tamper protection against enclosure opening and removal from mounting surface.
- 2 magnets included (for surface and flush mounting).

Magnetic contact

- Detects open door, window, etc.
- Input for connecting an NC type wired detector (e.g. other magnetic contact).
- 1 alarm output.

Shock detector

- Detects shocks and vibrations accompanying attempts to force open a door or window.
- Input for connecting an NC type wired detector (e.g. other magnetic contact).
- 1 alarm output.

Shock detector and magnetic contact

- Detects shocks and vibrations accompanying attempts to force open a door or window.
- Detects open door, window, etc.
- Input for connecting an NC type wired detector (e.g. other magnetic contact).
- 1 or 2 alarm outputs.

Water flood detector

- Detects flooding in spaces provided with plumbing systems.
- 1 alarm output.



Flood probe is not included with the detector. The FPX-1 probe is offered by SATEL.

2. Description

Alarms

Opening the tamper switch will turn on the tamper output (tamper alarm). The circumstances in which the alarm output will open depend on the detector type.

Magnetic contact

Alarm output will turn on after:

- moving the magnet away from the detector (opening the window or door),
- opening the SNS input.

Shock detector

Alarm output will turn on after:

- detecting a shock caused by a single strong impact,
- detecting a defined number of minor shocks caused by a series of light impacts,
- opening the SNS input.

Shock detector and magnetic contact

Alarm output will turn on after:

- detecting a shock caused by a single strong impact,
- detecting a defined number of minor shocks caused by a series of slight impacts,
- moving the magnet away from the detector (opening the window or door),
- opening the SNS input.

Water flood detector

The alarm output will turn on approximately 1 second after the water level reaches the height at which the probe contacts are installed. The alarm output will turn off a few seconds after the water level drops below the height at which the probe contacts are installed.

Additional alarm output

When the detector works as a shock detector and magnetic contact, you can use 1 or 2 alarm outputs. If you enable the two output mode:

- the NC output will indicate alarms from the magnetic sensor and the SNS input,
- the S output will indicate alarms from the shock sensor.

When the two output mode is disabled, all alarms will be indicated by the NC output.

You can enable / disable the two output mode by using the DIP switch (see: "Two output mode enable / disable").

Supply voltage control

If the voltage drops below 9 V ($\pm 5\%$) for more than 2 seconds, the detector will signal a trouble condition. When the trouble condition is present, the NC alarm output and the LED indicator are ON. If the two output mode is enabled in the shock detector and magnetic contact, the trouble condition is indicated by the NC and S outputs. The trouble is indicated for as long as the condition is present.

LED indicator

The red LED indicates:

- minor shock detected (does not reach the sensitivity threshold) – short flash,
- alarm triggered by a shock – ON for 2 seconds,
- alarm triggered by opening the window or door / opening the SNS input / detecting water flooding – ON for as long as the condition that triggered the alarm is present,
- trouble – ON for as long as the trouble condition is present.

The LED is also used during configuration of the shock detector (see: “Configuring the shock detector settings”).

You can enable / disable the LED. When disabled, the LED will not indicate the events described above, except for the trouble condition.

Enabling the LED with a DIP switch

If you enable the LED with a DIP switch (by setting the switch to LED position), the LED will indicate events but remote LED enable / disable will be impossible. Disable the LED with the switch if you want to enable / disable the LED remotely.

Remote LED enable / disable

The LED terminal is provided to allow remote LED enable / disable. When the terminal is connected to common ground, the LED is enabled. When the terminal is disconnected from common ground, the LED is disabled.

If the detector is used in the INTEGRA / INTEGRA Plus alarm system, you can connect to the terminal an OC type control panel output programmed e.g. as “Zone test status” or “BI switch”.

3. Electronics board



Do not remove the electronics board from the enclosure to avoid damage to the components on the board.

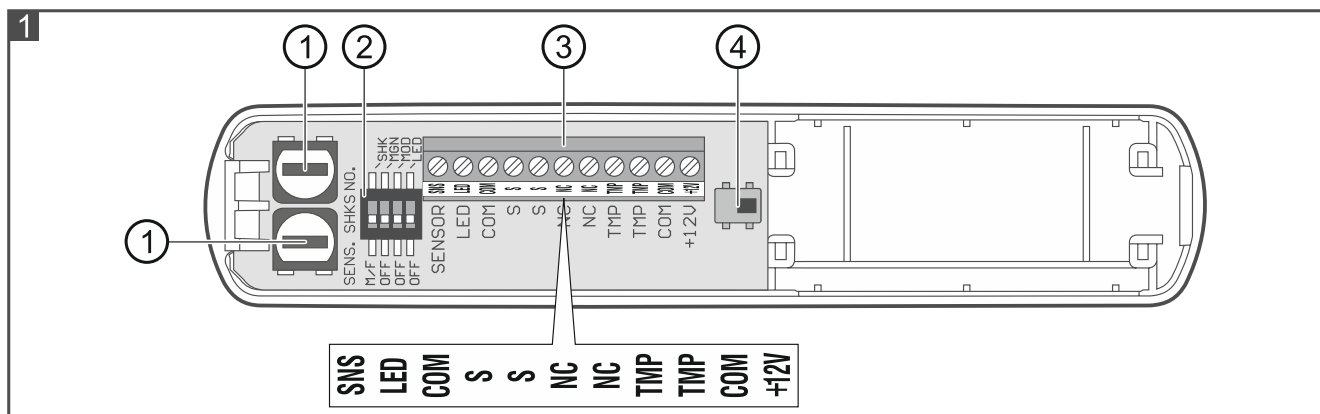

① potentiometers for configuring the shock detector (see: “Configuring the shock detector settings”).

② DIP switches for configuring the detector (see: “Configuring the detector settings”).

③ terminals:

SNS - input for connecting an NC type detector (e.g. magnetic contact) or a flood probe. Cable length may not exceed 3 m. If no detector or flood probe is connected to the input, the terminal must be connected to common ground.

LED - enable / disable the LED indicator.

S - alarm output (NC relay) used when the two output mode is enabled (see: “Two output mode enable / disable”).

NC - alarm output (NC relay).

TMP - tamper output (NC).





COM - common ground.

+12V - power input.

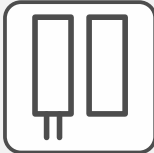
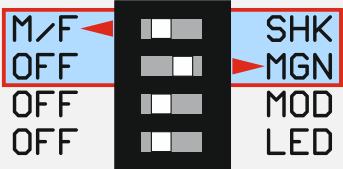

④ tamper switch activated by enclosure opening and removal from mounting surface.
The LED is located on the other side of the electronics board.

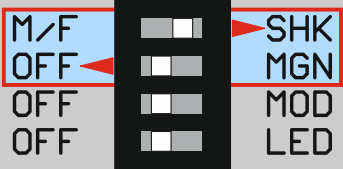
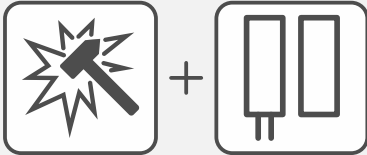
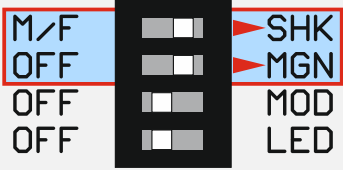
4. Configuring the detector settings

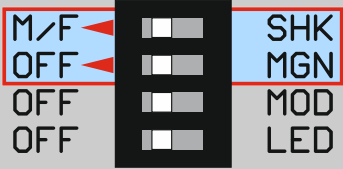



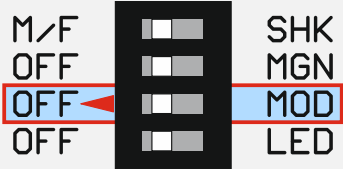

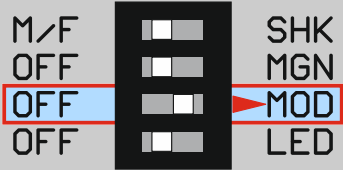



Selecting the detector type

Detector type		Switch setting
Magnetic contact		
Shock detector		
Shock detector and magnetic contact		
Water flood detector		

Two output mode enable / disable

Two output mode		Switch setting
Disabled		
Enabled		

LED enable / disable

	LED	Switch setting
Disabled		M/F  SHK OFF  MGN OFF  MOD OFF  LED
Enabled		M/F  SHK OFF  MGN OFF  MOD OFF  LED

Configuring the shock detector settings

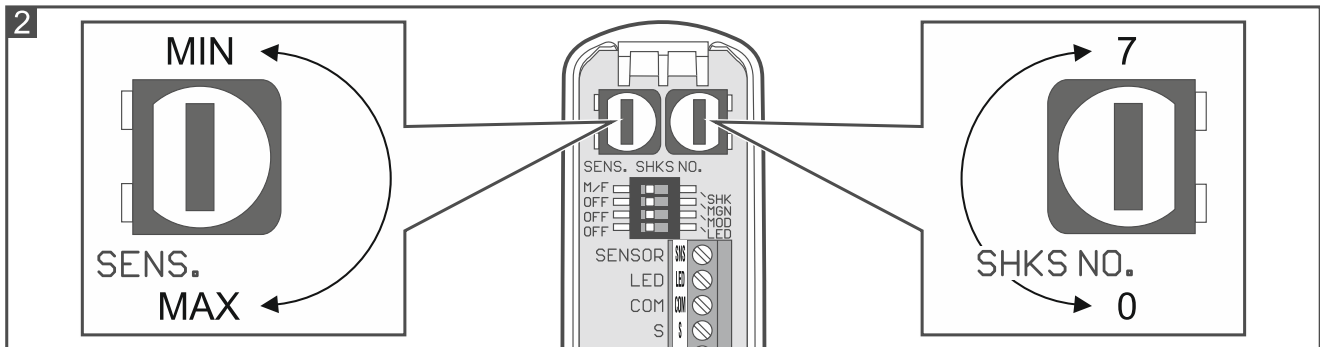

Use the “**SENS.**” potentiometer to set the sensitivity of the shock detector (Fig. 2). When a single shock is registered and it reaches the sensitivity threshold, alarm will be triggered.

Use the “**SHKS NO.**” potentiometer to set the number of shocks that will trigger alarm if they are registered within 30 seconds (Fig. 2). The shocks do not need to reach the sensitivity threshold. You can set 0-7 shocks. If you set 0, alarm will be triggered only by a shock that reached the sensitivity threshold. After the settings are changed, the new value will be demonstrated by the LED (the number of flashes corresponds to the number of shocks).



The sensitivity and the number of shocks are analyzed independently. Alarm will be triggered by a single strong shock caused by a hard impact, or several minor shocks caused by a series of light impacts.

5. Installation



Disconnect power before making any electrical connections.

The detector is designed for indoor installation. Consider the detector type when selecting the place of installation. Mount the magnetic contact on a fixed surface (window / door frame) and the magnet on a moving surface (window / door). When selecting the place of installation for the shock detector, remember that its detection range depends on the type of mounting surface. Mounting the detector on ferromagnetic surfaces or near strong magnetic and electrical fields is not advisable, because it can result in malfunction of the detector.



If the detector is to be installed on the window frame, select the upper part of the frame for this purpose. This will reduce the probability of the detector being flooded by accident, when the window is partially or fully open.

Prepare the cables for making connections and run them to the location where the device will be installed. The cabling should not be run in close vicinity of low-voltage electrical system wires, and especially of power wires for high-power equipment (such as electric motors).

You will need the following tools to mount the detector:

- blade screwdriver 1.8 mm,
- Philips screwdriver,
- precision pliers,
- drill with a set of drill bits.

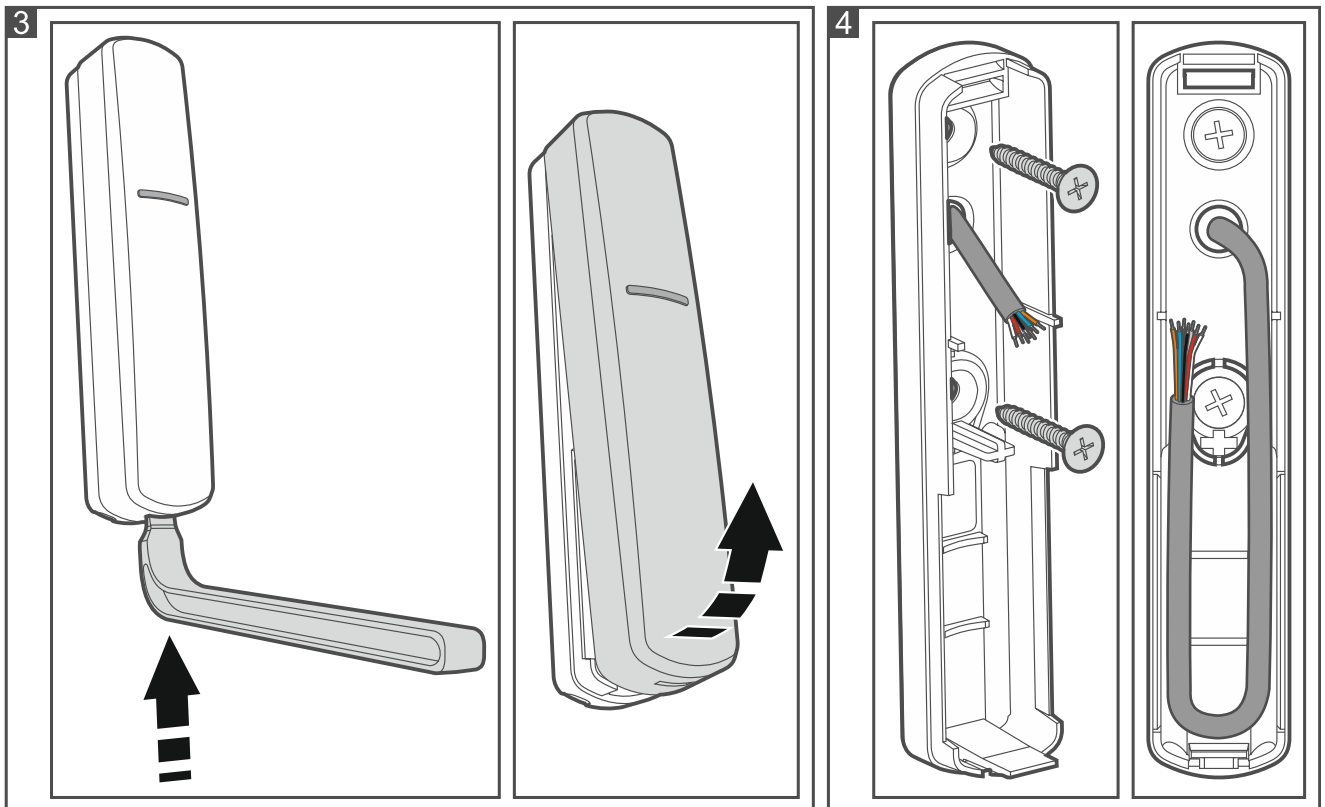

1. Open the detector enclosure (Fig. 3). The enclosure opening tool, shown in the illustration, is delivered with the detector.
2. Configure the detector (see: “Configuring the detector settings”).
3. Make the opening for cable in the enclosure base.
4. Run the cable through the opening (Fig. 4).
5. Using wall plugs (anchors) and screws, secure the enclosure base to the mounting surface (Fig. 4). The wall plugs delivered with the device are intended for concrete, brick, etc. For other types of surface (drywall, styrofoam), use the appropriately selected wall plugs.
6. Place the cable in the enclosure base as shown in Fig. 4.
7. Connect the wires to the appropriate terminals.

8. Close the detector enclosure.
9. For the magnetic contact, install the magnet (Fig. 5), taking into account the maximum permissible distance from the magnetic sensor (Fig. 6 and 7). The shown distance applies to the magnet located at the height of the sensor. Location of the sensor in the enclosure is shown in Fig. 8.
10. Power up the detector.
11. Test the detector (see: "Detector test").
12. For the water flood detector, when the test is done, install the FPX-1 probe as shown in Fig. 9. Install the probe just above the floor.

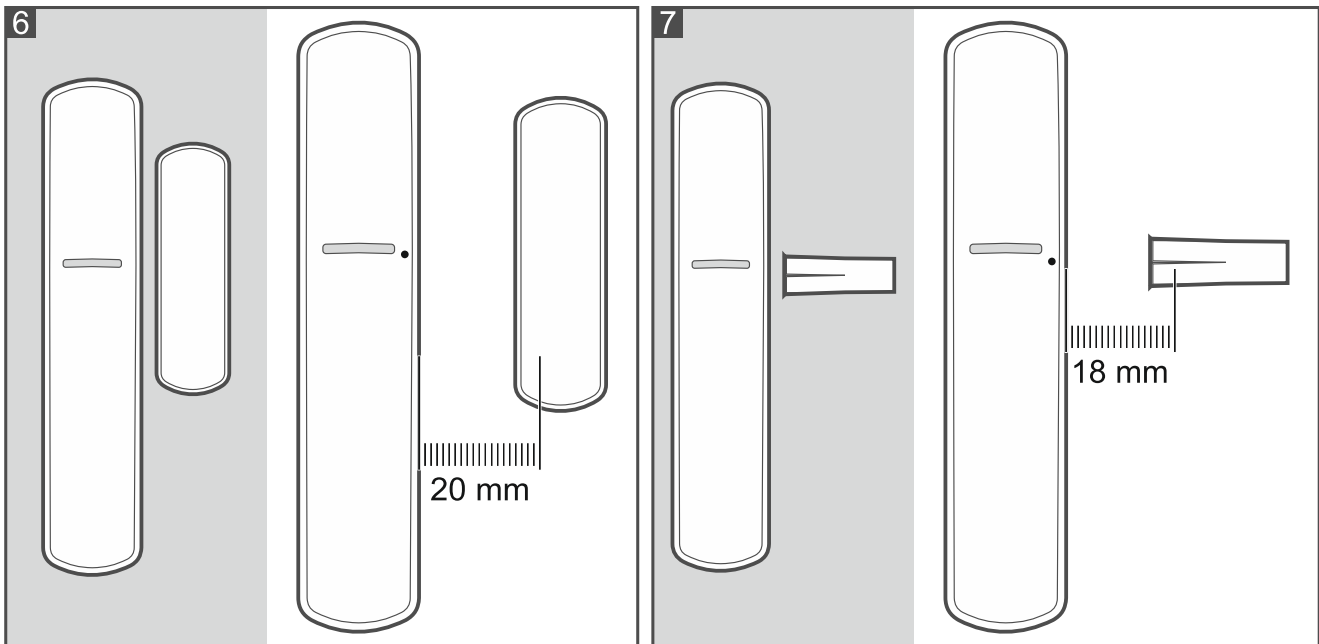
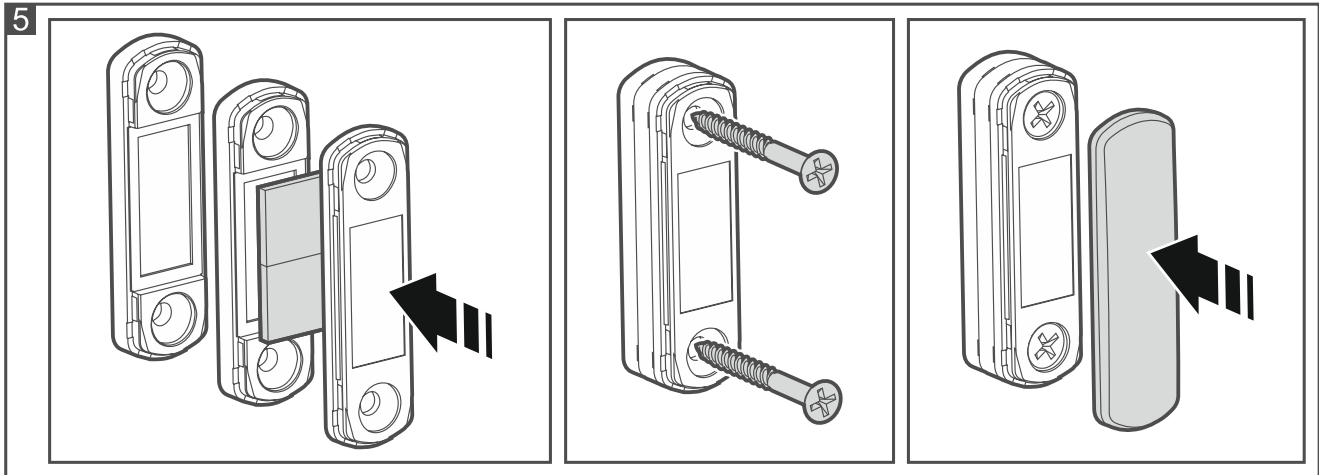

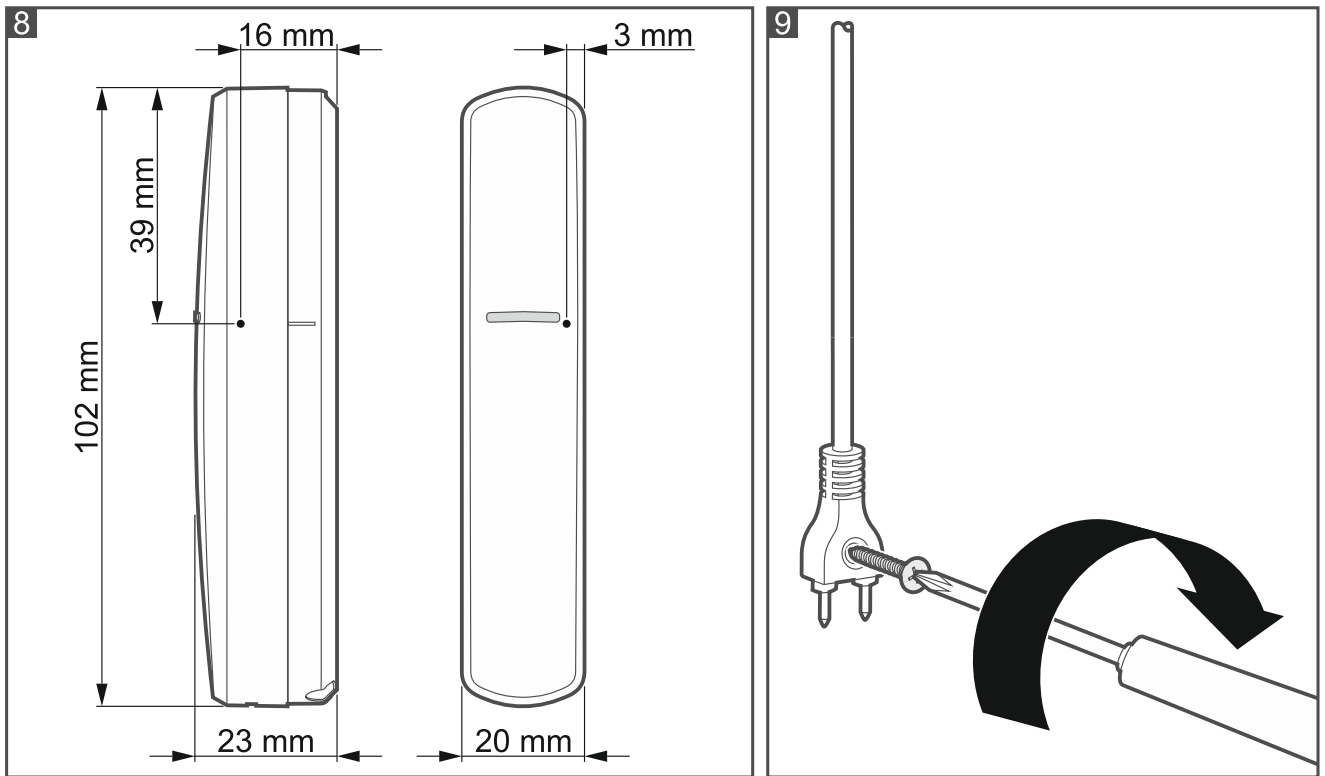

6. Detector test



Make sure the LED is enabled, before you test the detector.

Check if the LED turns ON:

- magnetic contact: after moving the magnet away from the detector (opening the window or door),
- shock detector: after impact against the surface protected by the detector,



The shock detector range depends on the type of surface on which the detector is installed. The specified detection range (up to 3 m) should be considered an approximate value. The actual detection range should be tested.

- water flood detector: after submerging the flood probe contacts in water.

If a detector is connected to the SNS input, check if the LED on the XD-2 detector will turn ON when that detector is violated.

7. Specifications

Supply voltage	12 VDC ±25%
Standby current consumption	12.5 mA
Maximum current consumption	14 mA
Outputs	
NC alarm (NC relay, resistive load)	40 mA / 24 VDC
S alarm (NC relay, resistive load)	40 mA / 24 VDC
tamper (NC)	40 mA / 24 VDC
Relay contact resistance	
NC alarm output	26 Ω

S alarm output	26 Ω
SNS input sensitivity:	
NC type detector	150 ms
flood probe	1 s
Complied with standards	EN 50130-4, EN 50130-5, EN 50131-1, EN 50131-2-6
Security grade according to EN 50131-2-6	Grade 2
Environmental class according to EN 50130-5	II
Operating temperature range	-10°C...+55°C
Maximum humidity	93±3%
Enclosure dimensions	20 x 102 x 23 mm
Surface mounted magnet enclosure dimensions	15 x 52 x 6 mm
Surface mounted magnet spacer dimensions	15 x 52 x 6 mm
Flush mounted magnet enclosure dimensions	∅10 x 28 mm
Weight	46 g

Magnetic contact

Gap (max.):

surface magnet	20 mm
flush magnet	18 mm

Shock detector

Detection range (depending on the surface type) up to 3 m