



## Foreword

### General

This user's manual (hereinafter referred to be "the Manual") introduces the functions, installation and operations of the camera.

### Safety Instructions

The following categorized signal words with defined meaning might appear in the Manual.

Signal Words	Meaning
WARNING	Indicates a medium or low potential hazard which, if not avoided, could result in slight or moderate injury.
CAUTION	Indicates a potential risk which, if not avoided, could result in property damage, data loss, lower performance, or unpredictable result.
NOTE	Provides additional information as the emphasis and supplement to the text.

### Privacy Protection Notice

As the device user or data controller, you might collect personal data of others' such as face, fingerprints, car plate number, Email address, phone number, GPS and so on. You need to be in compliance with the local privacy protection laws and regulations to protect the legitimate rights and interests of other people by implementing measures include but not limited to: providing clear and visible identification to inform data subject the existence of surveillance area and providing related contact.

### About the Manual

- The Manual is for reference only. If there is inconsistency between the Manual and the actual product, the actual product shall prevail.
- We are not liable for any loss caused by the operations that do not comply with the Manual.
- The Manual would be updated according to the latest laws and regulations of related regions. For detailed information, see the paper User's Manual, CD-ROM, QR code or our official website. If there is inconsistency between paper User's Manual and the electronic version, the electronic version shall prevail.

- All the designs and software are subject to change without prior written notice. The product updates might cause some differences between the actual product and the Manual. Please contact the customer service for the latest program and supplementary documentation.
- There still might be deviation in technical data, functions and operations description, or errors in print. If there is any doubt or dispute, please refer to our final explanation.
- Upgrade the reader software or try other mainstream reader software if the Guide (in PDF format) cannot be opened.
- All trademarks, registered trademarks and the company names in the Manual are the properties of their respective owners.
- Please visit our website, contact the supplier or customer service if there is any problem occurred when using the device.
- If there is any uncertainty or controversy, please refer to our final explanation.

## Important Safeguards and Warnings



### Electrical Safety

- All installation and operation should conform to your local electrical safety codes.
- The power source shall conform to the requirement of the Safety Extra Low Voltage (SELV) standard, and supply power with rated voltage which conforms to Limited power Source requirement according to IEC60950-1. Please note that the power supply requirement is subject to the device label.
- A readily accessible disconnect device shall be incorporated in the building installation wiring.
- Make sure if the camera power adapter meets the camera operating voltage requirement before powering up the device (The material and length of the power cable might influence the device voltage).
- Prevent the power cable from being trampled or pressed, especially the plug, power socket and the junction extruded from the device.
- We assume no liability or responsibility for all the fires or electrical shock caused by improper handling or installation.

### Environment

- Do not aim the device at strong light to focus, such as lamp light and sun light.
- Transport, use and store the device within the range of allowed humidity and temperature.
- Keep the camera away from water or other liquid to avoid damages to the internal components.
- Keep sound ventilation to avoid heat accumulation.
- Heavy stress, violent vibration or water splash are not allowed during transportation, storage and installation.
- Pack the device with standard factory packaging or the equivalent material when transporting the device.
- It is recommended to use the device together with lightning arrester to improve lightning protection effect.
- It is recommended to ground the device to enhance reliability.
- It is recommended to use qualified video transmission cable to improve video quality. It is recommended to use RG59 coaxial cable or higher standard.



- Use standard components or accessories provided by manufacturer and make sure the device is installed and maintained by professional engineers.
- The surface of the image sensor should not be exposed to laser beam radiation in an environment where a laser beam device is used.
- Do not provide two or more power supply sources for the device; otherwise it might damage the device.
- When the camera is in the condition of PoC power supply, do not connect any other device between the camera and PoC transceiver including UTC, Balun, optical transceiver, distributor and convertor and so on; otherwise, the device might get burned.
- PoC supply voltage is up to 52V. Do not dismantle the device during normal operation; otherwise it might cause danger to both device and users due to high voltage.

## 1 Introduction

### 1.1 General

This series of products comply with the HDCVI standard and support the transmission of video and control signal over coaxial cable. They produce video signal with megapixel resolution and require XVR device that comply with the HDCVI standard to achieve high speed, long distance and zero lag transmission of the signal. They are applicable to cover the high definition monitoring needs for locations like financial center, telecom site, supermarket, hotel, government, school and factory.

## 2 Design

### 2.1 Dimension

Figure 2-1 Device dimension (mm [in])

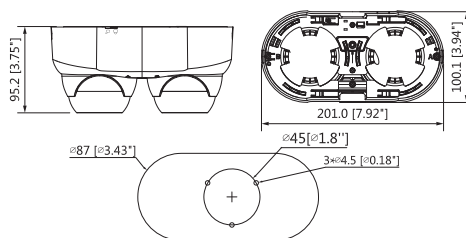

### 2.2 Cable



Cable type might vary with different cameras, and the actual product shall prevail.

#### 2.2.1 Cable Layout

Figure 2-2 Cable layout

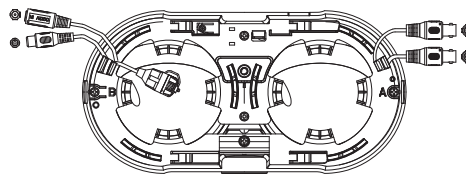

#### 2.2.2 Cable Introduction

Figure 2-3 DC 12V Power input



Figure 2-4 DC 12V or AC 24V Power input



Figure 2-5 Video output

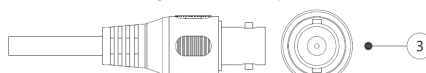

Figure 2-6 Audio input

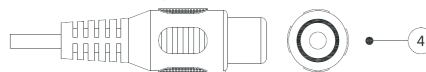
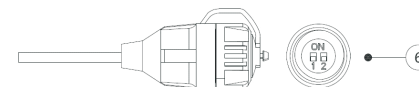

Figure 2-7 Power output



Figure 2-8 DIP switch



For more information about cable ports, see Table 2-1; for the operation method of ⑥ (DIP switch), see Table 2-2.

Table 2-1 Cable function

No.	Port Name	Function
①	12V DC Power Input	Inputs 12V DC power. Please be sure to supply power as instructed in the Manual. CAUTION Device abnormality or damage could occur if power is not supplied correctly.
②	12V DC or 24V AC Power Input	Inputs 12V DC or 24V AC power. Please be sure to supply power as instructed in the Manual. CAUTION Device abnormality or damage could occur if power is not supplied correctly.
③	Video Output	Connects to XVR to output video signal.
④	Audio Input	Connects to sound-pick-up devices to receive audio signal.
⑤	Power Output	Supplies 12V DC/24V AC 2W power.
⑥	DIP Switch	Dial switches to change output mode. Switch up indicates "ON", switch down indicates "OFF".

Table 2-2 DIP switch operation

Switch1	Switch2	Output Mode
OFF	OFF	CVI
ON	ON	CVBS
ON	OFF	AHD
OFF	ON	TVI

## 3 Installation



Make sure the mounting surface is strong enough to hold at least three times of the camera weight.



The following figures are for reference only, and the actual product shall prevail.

### 3.1 Installation Type

For installation types, see Figure 3-1 and Table 3-1.



The corner bracket needs to be purchased separately.

Figure 3-1 Installation type

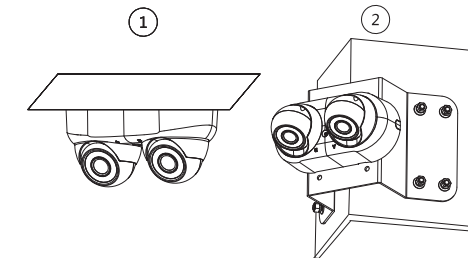

Table 3-1 Installation type list

No.	Type
①	Ceiling-mounted
②	Corner-mounted

### 3.2 Installing Device

For the installation diagram and item list, see Figure 3-2 and Table 3-2.

Figure 3-2 Installation diagram

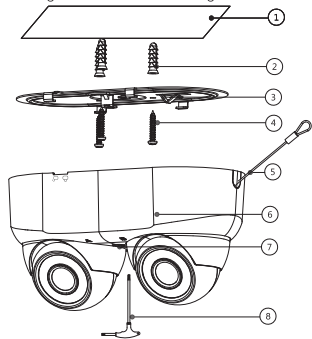

Table 3-2 Installation item list

No.	Item	No.	Item
①	Mounting surface	②	Expansion bolt
③	Mounting plate	④	Self-tapping screw
⑤	Strap	⑥	Device
⑦	Locking screw	⑧	Wrench

Step 1 Drill screw holes (and the cable outlet hole if it needs to go through the mounting surface) on the mounting surface ① as indicated on the mounting plate ③, then insert expansion bolts ② in the screw holes.

Step 2 Put in and fasten the self-tapping screws ④ to attach the mounting plate ③ to the mounting surface ①.

Step 3 Connect the cables and adjust their location according to cable outlet requirement (top out or back out), then pull the cable out through mounting surface or the cable tray on the back.

Step 4 Push the device to the mounting plate ③ and slide to align the lock sign and the indicator on the mounting plate ③ to lock the buckle, see Figure 3-3.

Figure 3-3 Device attaching

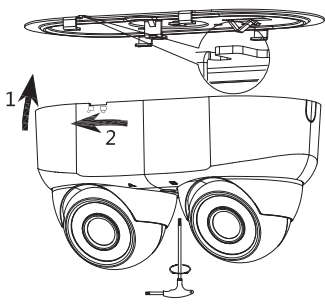

Step 5 Connect the device to power source and the XVR device, and then aim the lens to the ideal angle, see Figure 3-4.

Figure 3-4 Lens angle adjusting

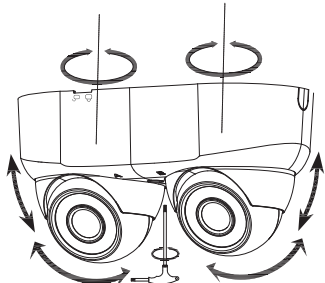

Step 6 Fasten the locking screw ⑦ with the supplied wrench ⑧.

**NOTE**

The space on top of the device can be used to place connected cables including audio, video and power.

## 4 Installing Device

Power up the camera and connect it to XVR device with coaxial cable, then the main screen is displayed. The following instructions will guide you to configure your camera.

**NOTE**

- The number of the coaxial port on XVR will display at the lower left corner of each window to indicate the corresponding camera.
- Interfaces of different XVR might vary, and the actual product shall prevail.

### 4.1 Opening Main Menu

Step 1 In the live view screen interface, right-click anywhere on the screen. The shortcut menu is displayed. See Figure 4-1.

Figure 4-1 Shortcut menu

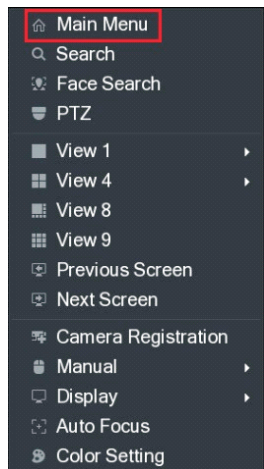

Step 2 Click **Main Menu**.

The **Main Menu** interface is displayed. See Figure 4-2.

Figure 4-2 Main menu interface

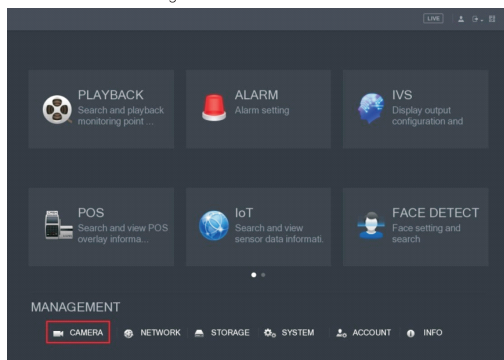

**NOTE**

Right-click anywhere on the screen to return to the previous interface until you goes back to main screen.

### 4.2 Setting Audio Input

**NOTE**

Audio signal acquisition is available on select models.

Step 1 In the **Main Menu** interface (Figure 4-2), select **CAMERA > ENCODE**

The **Encode** setting interface is displayed. See Figure 4-3.

Figure 4-3 Encode setting interface

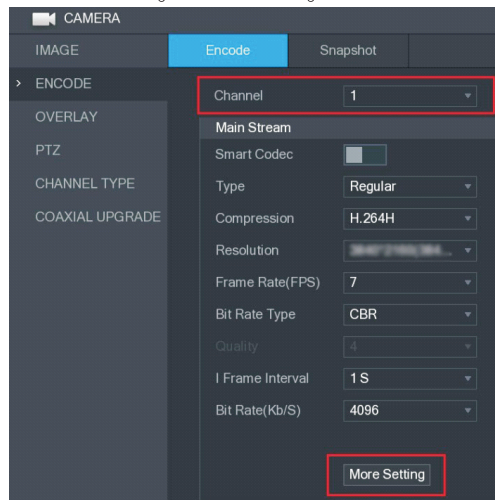

Step 2 In the **Channel** list, select the camera that you want to configure according to the coaxial port number.

Step 3 In the **Main Stream** column, click **More Setting**.

The **More Setting** interface is displayed, see Figure 4-4.

Figure 4-4 More setting interface

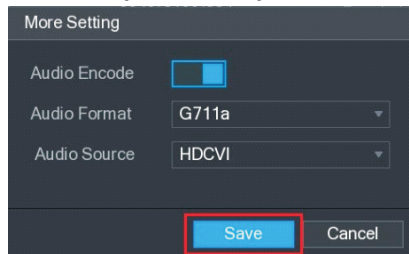

Step 4 In the **More Setting** interface, you can configure the audio settings.

- Enable **Audio Encode** function.
- In the **Audio Format** list, leave to the default.
- In the **Audio Source** list, select **HDCVI**.

Step 5 Click **Save** to save the settings.

The **Encode** setting interface is displayed (Figure 4-3).

Step 6 In the **Encode** setting interface (Figure 4-3), click **Apply**.

### 4.3 Operating OSD Menu

**NOTE**

The **OSD** menus of different cameras might vary, and the actual product shall prevail.

Step 1 In the live view screen interface, right-click within the live view window of the camera that you want to configure.

The shortcut menu (Figure 4-1) is displayed.

Step 2 Click **PTZ**.

The **PTZ** setting interface is displayed. See Figure 4-5.

Figure 4-5 PTZ setting interface

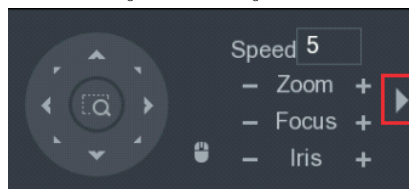

Step 3 Click **▶** to see more options. See Figure 4-6.

Figure 4-6 PTZ setting options

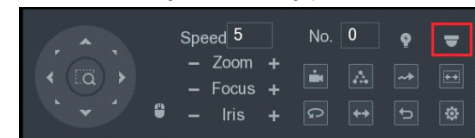

Step 4 Click **▼**.

The **MENU OPERATION** panel is displayed. See Figure 4-7.

The **OSD** menu of the corresponding camera is displayed on the live view screen.

Figure 4-7 Menu Operation panel

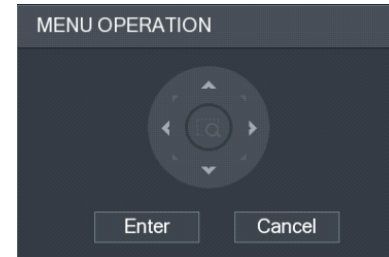

For the function of the buttons in the **MENU OPERATION** panel, see Table 4-1.

Table 4-1 Menu Operation panel function

Button	Function	Button	Function
Enter	Enter or confirm an item	▶	Select item
Cancel	Exit OSD menu	▼	Change item value

If there is '▶' or '▼' as the value of an **OSD** item, click **Enter** to go to the next level of this item. Click **Return** to go back to the previous level. Clicking **Cancel** is to exit **OSD** menu without saving the modifications.

## 5 Maintenance

**NOTE**

In order to maintain the image quality and proper functioning of the device, please read the following maintenance instructions carefully and hold rigid adherence.

### Disassembly and Desiccant Replacement

- Carefully follow the instructions in the manual when performing any disassembly operation about the device; otherwise, it might cause water leakage or poor image quality due to unprofessional disassemble.
- Please contact after-sale service for desiccant replacement if there is condensed fog found on the lens after unpacking or when the desiccant turns green. (Not all models are included with the desiccant).

### Maintaining Lens and Mirror Surface

- The lens and mirror surface are covered with antireflection coating, which could be contaminated or damaged and result in lens scratches or haze image when being touched with dust, grease, fingerprints and other similar substances.
- Do not touch the image sensor directly (CCD or CMOS). Dust and dirt could be removed with air blower, or you can wipe the lens gently with soft cloth that moistened with alcohol.

### Maintaining Device Body

- Device body can be cleaned with soft dry cloth, which can also be used to remove stubborn stains when moistened with mild detergent.
- To avoid possible damage on device body coating which could cause performance decrease, do not use volatile solvent such as alcohol, benzene, diluent and so on to clean the device body, nor can strong, abrasive detergent be used.