



WARNING

THOR

USER GUIDE - 28082T

40-70"

Fixed Super Slim TV Wall Mount

- We have not supplied wall fixings with this product. All walls differ in strength and thickness. Consult a qualified installer or seek advice from your local DIY/hardware store on purchasing suitable wall fixings to safely mount the bracket on the type of wall being used.
- Check the components list and images to check there are no missing or defective parts.
- Never exceed the Maximum Weight Capacity.
- Read these instructions carefully before installation. If in any doubt about safely installing this product, contact a professional installer for assistance.
- This product was designed to be installed on wood stud walls and solid concrete/brick walls. When fixing to walls screws/bolts should be fixed into bricks/stone not into mortar courses.
- Make sure the wall will support the combined load of the equipment and hardware. Also check for hidden wiring or plumbing.
- Make sure that the heads of the screws/bolts you buy as wall fastenings are the correct size to hold the bracket securely in position.
- For larger/heavier TVs we recommend that you ask someone to assist you with lifting and positioning your TV.
- This product is suitable for indoor use only.
- Improper installation or use of this product can result in product failure, damage or personal injury.
- This product contains small items that could cause choking if swallowed, so keep these items away from children and pets.
- Appropriate safety equipment and proper tools must be used for installation. Always check manufacturer's operating and safety instructions before using tools and other equipment.



- TV Size range: **40-70"**
- Maximum weight capacity: **35kg**
- Mount function: **Fixed**
- Wall to TV distance: **19.5mm**
- Compatible with VESA sizes: **200 x 200, 400 x 200, 300 x 300, 400 x 400**

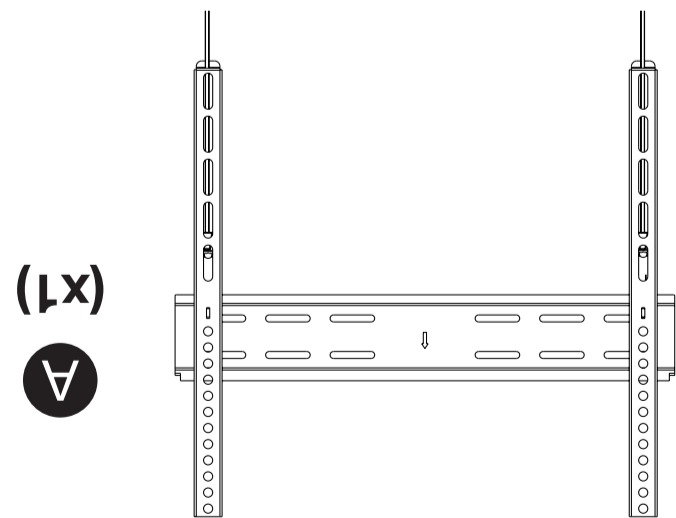
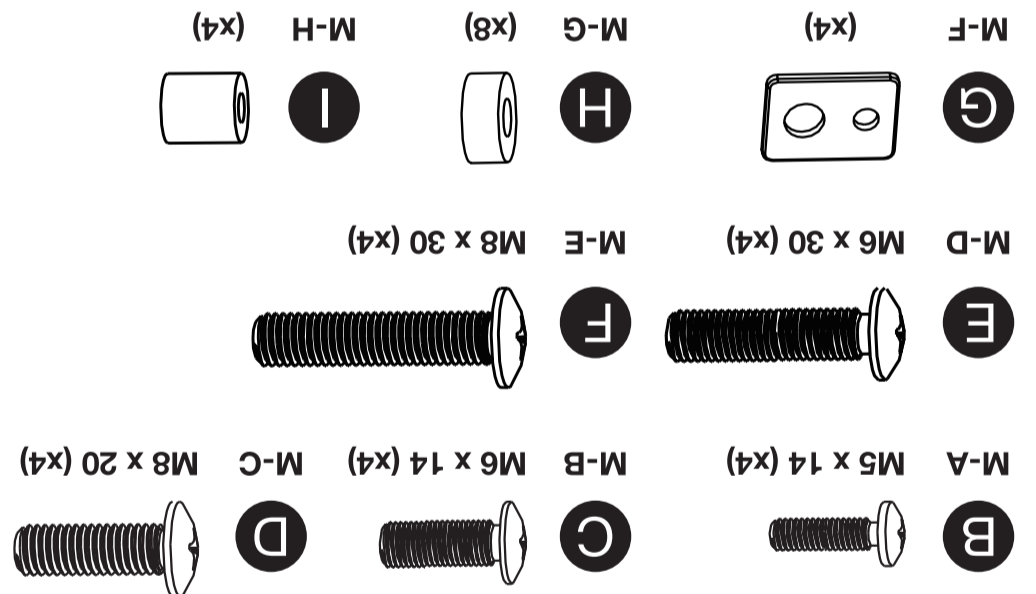
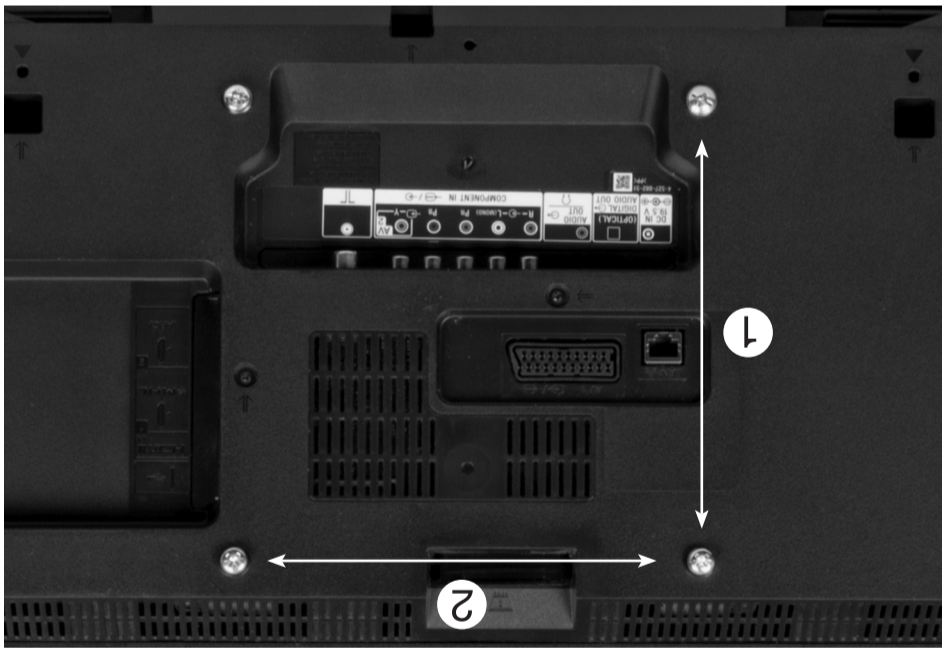

Before installation check that you have all the components shown here and that none of them are damaged.

- VESA is the standard adopted by most TV manufacturers for wall bracket mounting.
- There are 4 holes on the back of every flat screen TV and the space between the holes is governed by the VESA standard.
- VESA comes in a range of sizes depending on the weight and size of the flat screen TV; sizes 50 x 50mm, 75 x 75mm, 100 x 100mm, 200 x 100mm and so on... are standard. Not all flat screen TVs are compliant, contact the TV manufacturer for assistance if your TV does not appear to comply with VESA.
- To check if your TV or monitor is compliant, look at the rear of the display there should be 4 screw-holes in a square pattern or in larger displays a rectangular shape.
- Measure the distances marked (2) (horizontal) x (1) (vertical) below in mm to find your VESA format.

Wall Mount & VESA Compatibility

Components

1a. Preparing Wall Fixings - Stud Walls

Tools required

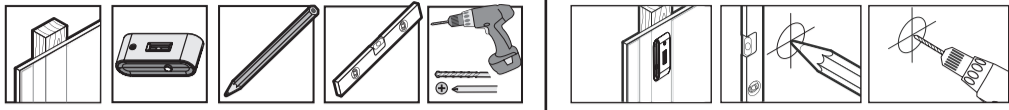

The wall bracket **A** is attached to the wall using four appropriate screws/bolts as shown in **Fig.2**. Make sure the screws/bolts are suitable for wood and large enough to support the weight of the TV and bracket (if in doubt ask for advice at your local DIY/hardware store and remember to make sure that the heads of the screws/bolts are the correct size to hold the bracket securely in position).

Mark and drill four holes into the wood as close as possible to the centre of the upright. To mark the holes, hold the bracket **A** to the wall, using a spirit level to make sure the bracket is level, and mark the centre of each hole, see **Fig.1**. Drill the four holes and attach the bracket **A** to the wall using the appropriate screws/bolts.

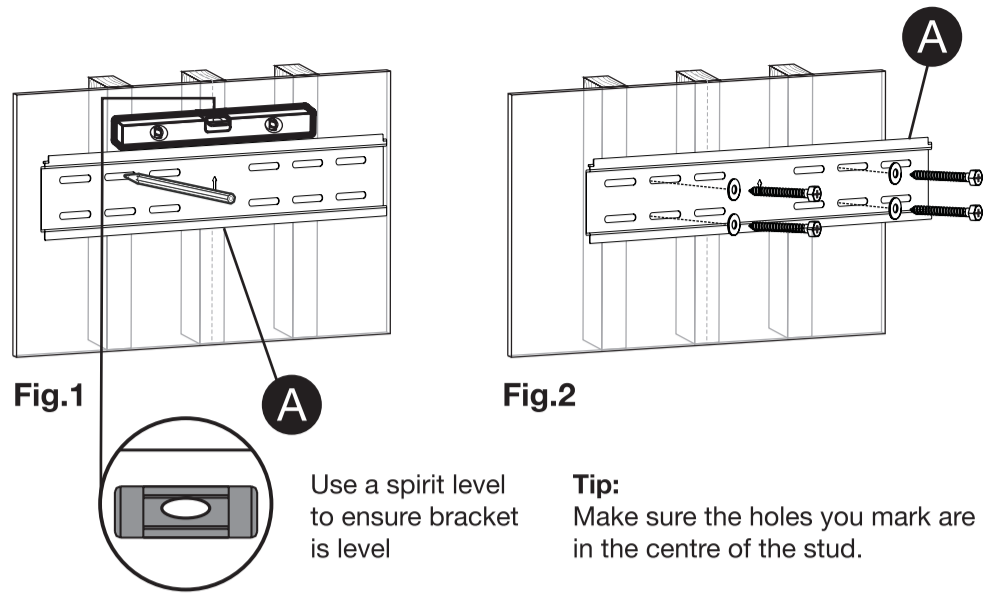

Fig.1

Fig.2

Use a spirit level to ensure bracket is level

Tip: Make sure the holes you mark are in the centre of the stud.

1b. Preparing Wall Fixings - Concrete/Brick Walls

Tools required

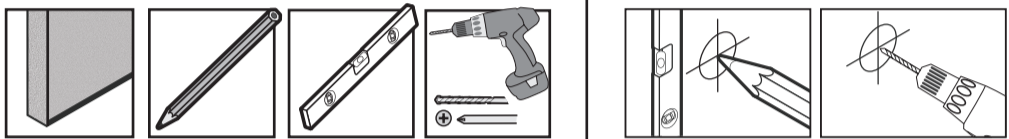

The process is the same as for attaching to wood see **Fig.1**. You will however need to use suitable screws/bolts/wall plugs for the type of wall you are mounting onto (if in doubt ask for advice at your local DIY/hardware store and remember to make sure that the heads of the screws/bolts are the correct size to hold the bracket securely in position). When fixing to walls screws/bolts should be fixed into bricks/stone not into mortar courses.

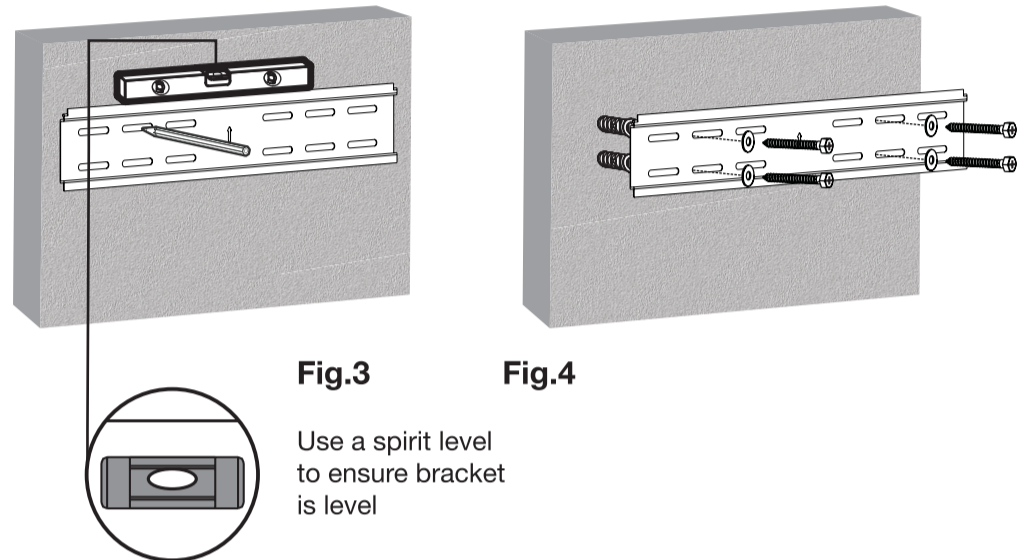

Fig.3

Fig.4

Use a spirit level to ensure bracket is level

3. Attaching the Adaptor Brackets

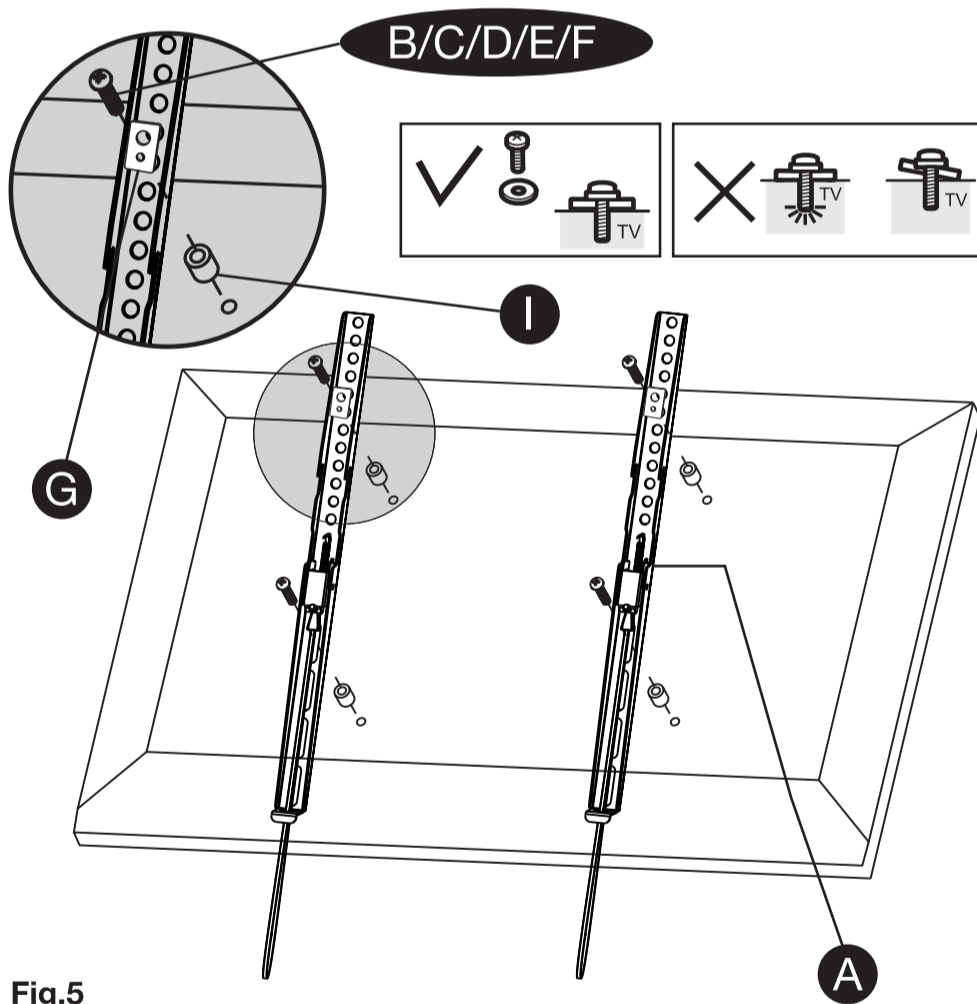

Fig.5

Select the correct size bolts to fit the VESA holes for your TV **B/C/D/E/F**. Attach the adaptor brackets to the back of the TV by lining up the VESA holes and using bolts **B/C/D/E/F** and the washers **G** to fix the TV securely to the adaptor brackets.

4. Mounting the TV to the Wall Plate

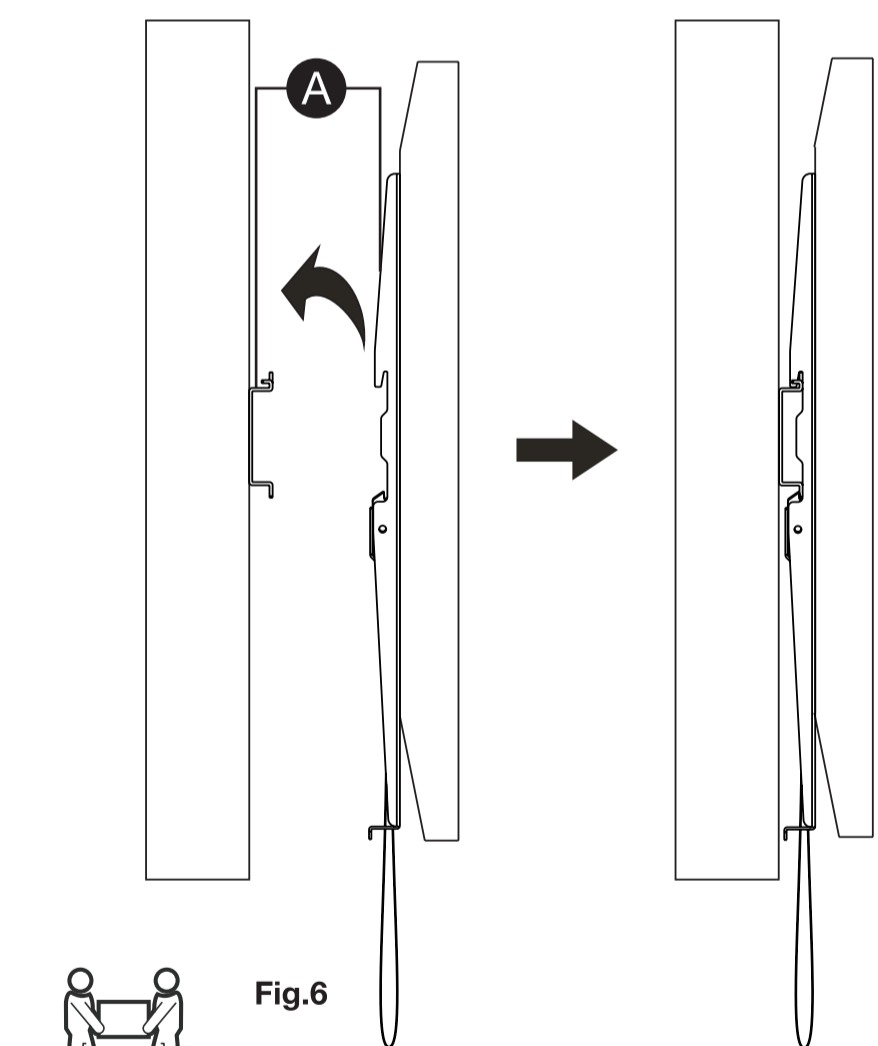

Fig.6



Lift with 2 people

With two people, lift and hold the TV in place while tightening the bottom bolts to secure the adaptor brackets to the wall plate.